

Ascent

High-Throughput Fraction Collector Quick Guide

Revision 1 – November 11, 2024

The Ascent instrument is an automated high-throughput fraction collector for isolation of extracellular vesicles (EVs) with size-exclusion chromatography (SEC) columns. It can run up to 8 columns in parallel and is compatible with Apex columns as well as other brands. The programmable fraction collection allows you to optimize collection for any application. The instrument can wash up to 8 columns with or without fraction collection.

COLUMN COMPATIBILITY	COLUMN RACK POSITION	TUBE RACK CONFIGURATION
Apex 4B	Bottom	Tube Rack + Platform
Apex 6B	Bottom	Tube Rack + Platform
Izon qEVoriginal	Bottom	Tube Rack + Platform
Izon qEVsingle	Bottom	Tube Rack Only
Izon qEVI	Top	Tube Rack Only

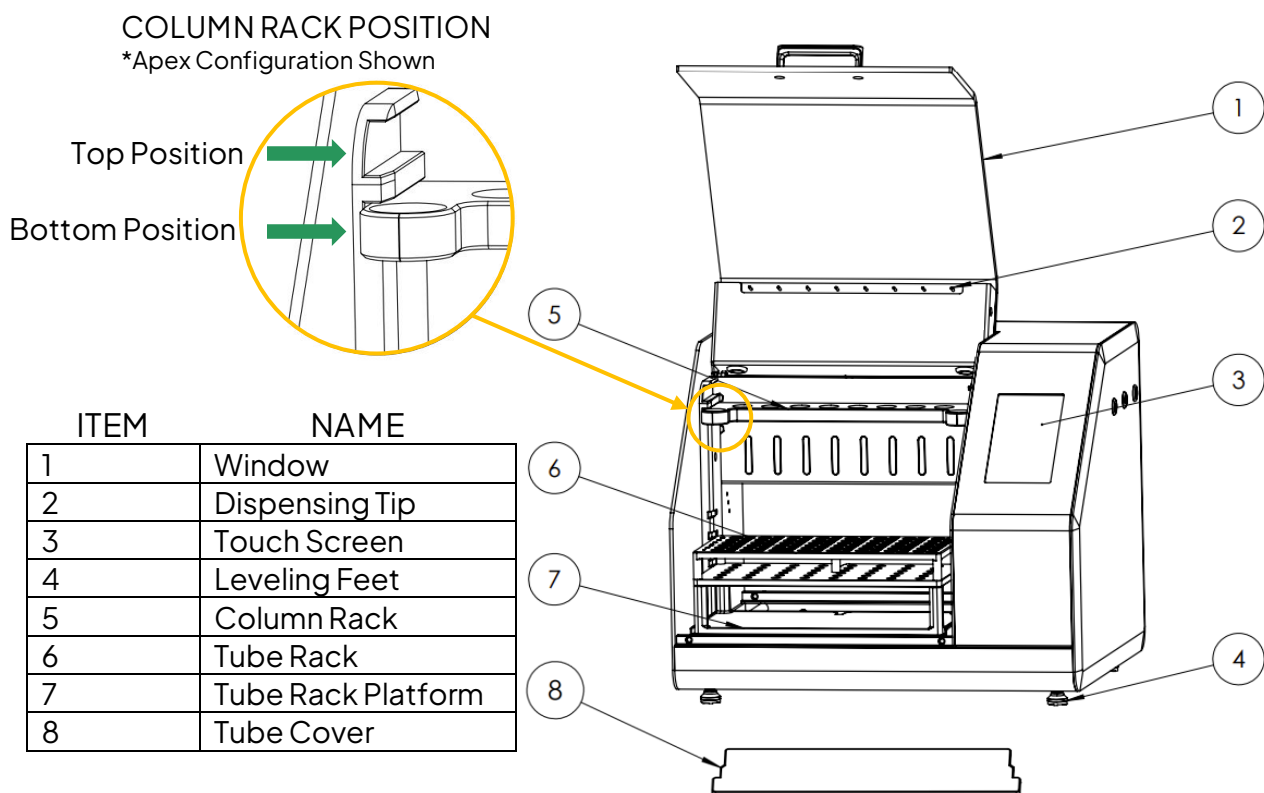

PROCEDURE

1. From the home screen press the “RUN” button.

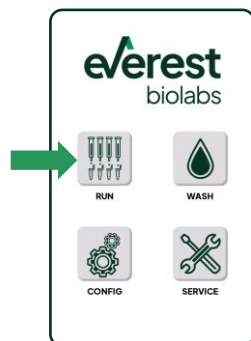

2. On the “RUN SETTINGS” screen, configure your collection parameters. First, select the column type. The remaining settings will populate with recommended values. You may adjust these values for your application

- Column Type – Apex, qEVoriginal, qEV1, qEVsingle
- Number of columns – 1 to 8 columns
- Wash Volume – 0-20 mL
- Discard Volume – 0-10 mL
- Number of Fractions to Collect – 1-12
- Fraction Volume – 0.1-2.0 mL

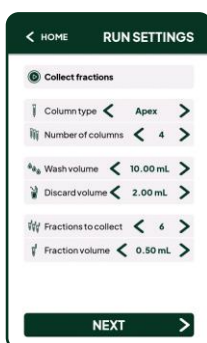

3. Select “NEXT” to go to the “OTHER OPTIONS” screen. This screen lets you set the post-run options:

- Enable post-run column wash
- Set volume of post-run column wash
- Enable water rinse of the instrument

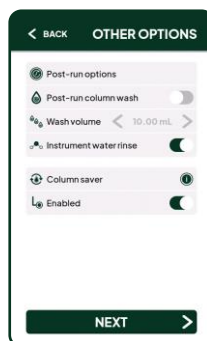

The *Column Saver* option will prevent columns from drying out if left unattended. It is used while waiting for samples to be added and at the end of a run.

4. Select “NEXT” to go to the “CHECK BOTTLES” screen where you must confirm that the buffer bottle, water bottle, and waste bottle have sufficient volume for the collection.



For buffer preparation see the APEX user guide.

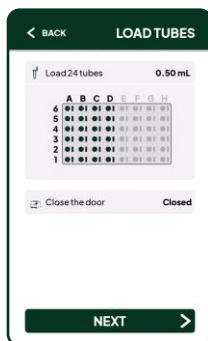

- After the instrument initializes, load the Tube Rack in the instrument. For Apex and qEVOriginal columns place the Tube Rack on the Tube Rack Platform. For qEVI and qEVsingle, use the Tube Rack alone.

When the tube rack is loaded, and the door is closed, you can proceed to the next screen.

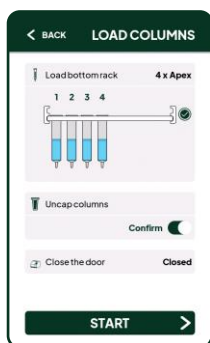
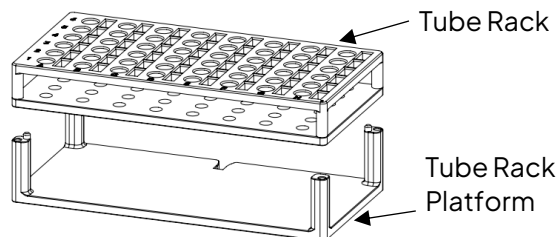

- Remove the top cap of the columns and place them in the instrument. Apex, qEVOriginal, and qEVsingle columns require the Column Rack to be placed in the bottom column rack position. qEVI columns go in the top position. Remove the tip caps before proceeding. qEVsingle columns require qEVsingle adapters which are available from Everest Biolabs.

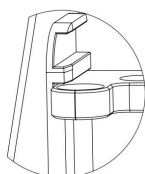

NOTE: The column rack must be in the correct position with the door closed to proceed. Apex configuration is shown.



- The “PROGRESS” screen shows the steps the instrument will perform, along with the current step, and experimental time.

When prompted, add samples and close the door. The instrument will collect the fractions and alert you when the collection is complete.

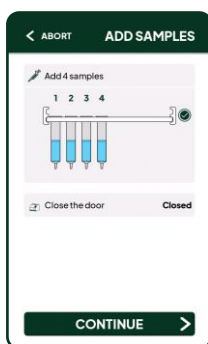

- The “ADD SAMPLES” screen lets you know it is time to open the door and add your samples to the columns.

When the samples are added, close the door and proceed to the next screen.

9. The “COMPLETE” screen shows the steps the instrument has performed and the experimental time.



COLLECTING MORE THAN 6 FRACTIONS

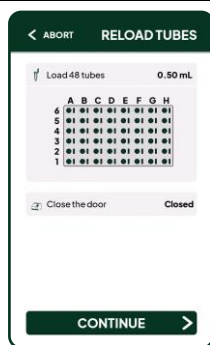

The Ascent Tube Rack is designed to collect up to 6 fractions on 8 columns. To collect more than 6 fractions, follow the software prompt and insert the tube cover in the slots on either side. The Tube Cover should be between the tubes and column tips as shown below. Replace the Tube Rack and continue.

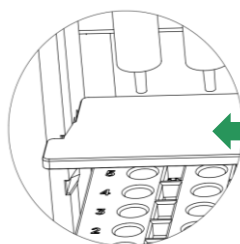

Slide Tube Cover in from the front.

MAINTENANCE

To ensure peak performance, use the optional water rinse after every run. This feature flushes the instrument with water to reduce salt build up. See step 3 above for enabling the water rinse.

We recommend monthly cleaning of the instrument and fluidic lines which is described in the Ascent user manual.

INSTRUMENT SPECIFICATIONS

Dimensions (WxDxH)	397mm x 364mm x 331mm (15-5/8" x 14-5/8" x 13")
Weight	13.6 Kg / 30.0 lbs.
Input Power	100~240 VAC (50-60Hz)
Power Supply Unit	24 VDC, 2.1A, 50W
Environmental Temperature	10°C -24°C (50°F-75°F)
Bottle Capacity	1000 mL
Connectivity	USB-C (for software updates)
Chemical Compatibility	PBS, DI, 70% ethanol, dilute bleach